

# DOWNLIGHT

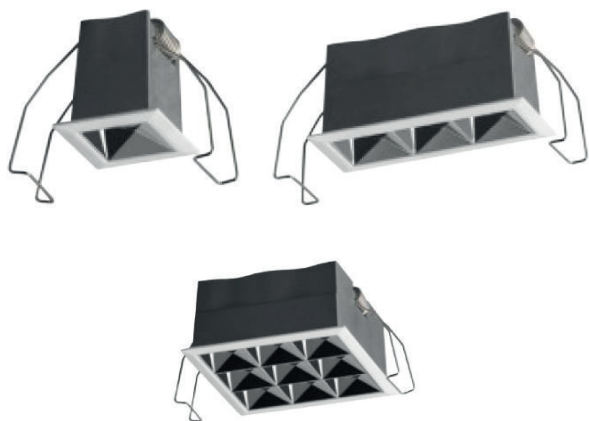

## ARRAY

<b>IP</b> 20	<b>CRI</b> RA>90	<b>UGR</b> >19	<b>AC220-240V</b>
-----------------	---------------------	-------------------	-------------------



### ARRAY DOWNLIGHT

High definition optics in metallized thermoplastic, built into the innovative black anti-glare screen that defines emission with controlled luminance UGR<19.

Precise beam angle: 12° /28° /34° /48°

The consideration of anti glare construction provides visual comfort.



## References

Reference	Led Power	Luminous flux	Input Voltage	CCT/K	OPTICS	IP Rating	Dimensions
LX-DL-15040F	3W	150lm	AC220-240V	2700K/3000K/4000K	12°/28°/34° /48°	IP20	45*45*50mm
LX-DL-15100F	6W	360lm					106*45*50mm
LX-DL-15160F	12W	740lm					165*45*50mm
LX-DL-15310F	24W	1560lm					316*45*50mm
LX-DL-15070FS	10W	600lm					76*76*50mm
LX-DL-15100FS	18W	1170lm					106*106*50mm

Order code : Reference - Power - Luminous flux - CCT/K - Optic

Important : All the specification can be customized as per the project request .

## Dimensions

LX-DL-15040F

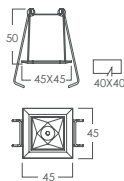

LX-DL-15100F

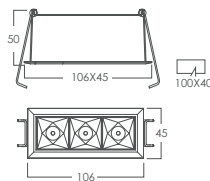

LX-DL-15160F

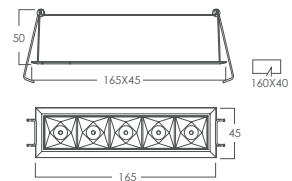

LX-DL-15310F

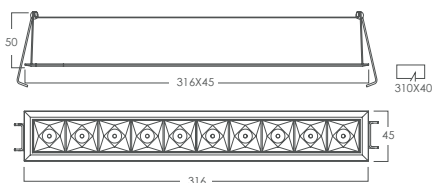
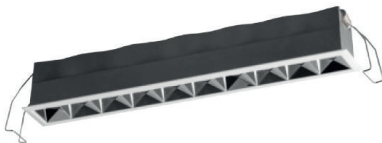

LX-DL-15070FS

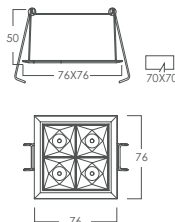
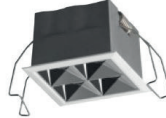

LX-DL-15100FS

