

DOWNLIGHT



LX-DL-MT11G(A)

IP	CRI	DC48V
20	90	

		CASAMBI
--	--	---------

	CE	RoHS	50000h
--	----	------	--------

- Material : AL6063, spraying surface
- Coating : Matte Black (RAL9005)
- CCT : 3000K,4000K optional
- Size : 112*16*89mm / 220*16*89mm
- Beam angle : 30°
- Light efficiency : 71 LM/W
- Lighting direction : Downward
- Application : Indoor



Luminaire Parameters

Version	Model	Length	Input Voltage (V)	Max. Current (A)	Type Power (W)	Max. Power (W)	CRI	Beam Angle	CCT	Lumen (LM)
Normal	LX-DL-MT11G(A)	112mm	48VDC	0.183	7.0	8.8	>90	30°	3000K	455lm
									4000K	490lm
		220mm		0.367	14.0	17.6			3000K	910lm
									4000K	980lm

Note:

1. The output data is based on the testing result of Ra90,3000k luminaires;
2. The tolerance of output data can be vary up to 10%;
3. The output data is typical value.

Dimensions

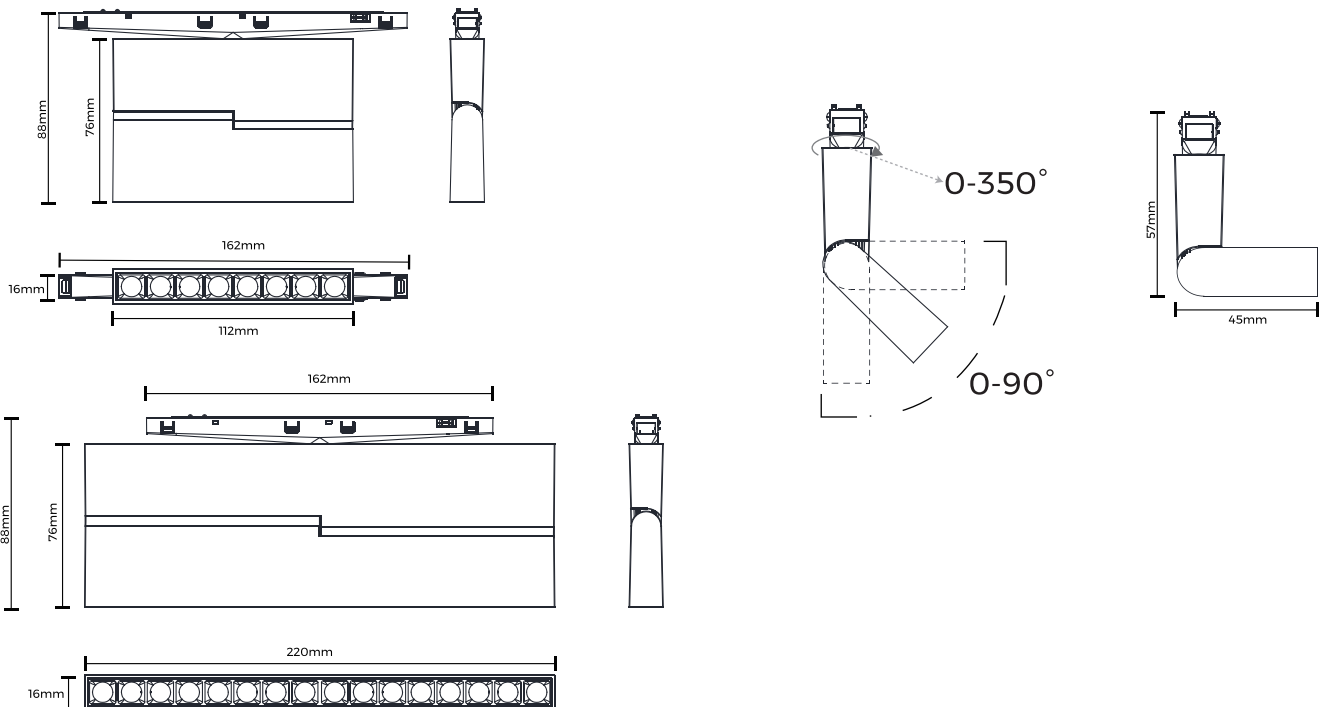

Optical Parameter

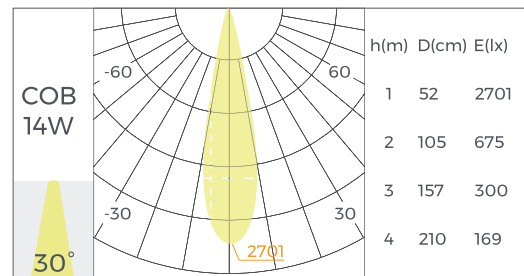
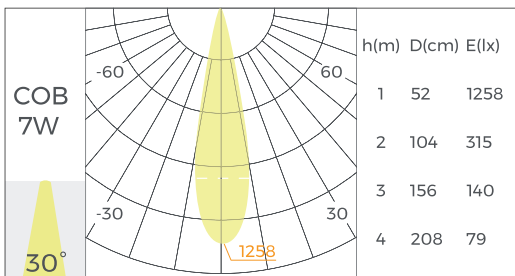

Points to note

48V Power Supply



Total track Length ≤ 50M

48V Power Supply

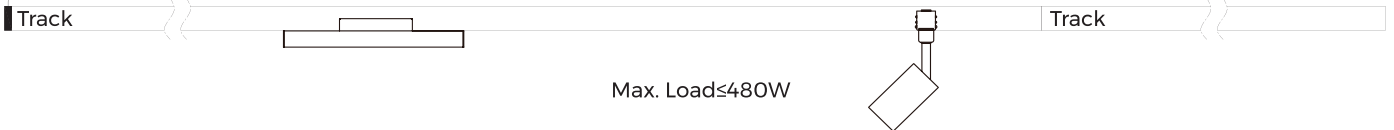

















Max. Load ≤ 480W

Supplementary power supplies are needed beside the Spotlights module / Decorative module / Linear modular under below one conditions:

1. Load > 480W on the track
2. Total track length > 50M

Accessories Information

Picture	Name	Model
	Trimless recessed track (13mm gypsum board)	LX-MT11-RX0
	Ceiling track	LX-MT11-SX0
	Pendant track	LX-MT11-HX0
	Pendant track	LX-MT11-SRX0
	ø1000mm 90° Ceiling curve track	LX-MS111090
	Rail energization box	LX-MT1101
	Horizontal corner power-on connectors	LX-MT1102
	Flexible energized connectors	LX-MT1103
	Rail energized connectors	LX-MT1104
	Pendant accessory	LX-MT1105
	Rail connectors	LX-MT1106
	End caps	LX-MT11-R-EC
	End caps	LX-MT11-S-EC
	End caps	LX-MT11-H-EC

Picture	Name	Model
	End caps	LX-MT11-SR-EC
	L-shaped (Inward)	LX-L90N-MS11
	L-shaped (Downward)	LX-L90-MS11
	L-shaped (Inward)	LX-L90N-MR11
	L-shaped (Downward)	LX-L90-MR11
	L-shaped (Inward)	LX-L90N-MH11
	L-shaped (Downward)	LX-L90-MH11
	L-shaped (Downward)	LX-L90-MSR11
	48V Constant Voltage Power supply(external)	LX-V48-XXXP
	48V Constant Voltage Power supply(build-in)	LX-100W48CG MICRO

Note:

- 1,Please refer to the accessory list table for detailed parameters.
- 2,Different tracks need to be used with corresponding accessories