

DOWNLIGHT



LX-DL-MT11SZ-32

IP 20	CRI 90	DC24-48V
-----------------	------------------	----------

--	--	--

			50000h
--	--	--	--------

- Material : AL6063, spraying surface
- Coating : Matte Black (RAL9005)
- Size : Ø32*65mm
- Beam angle : 12°-45°
- Light efficiency : 42 LM/W
- Lighting direction : Downward
- Application : Indoor



luxio
L I G H T I N G

www.luxio-lighting.com

Luminaire Parameters

Version	Model	Length	Input Voltage (V)	Max. Current (A)	Type Power (W)	Max. Power (W)	CRI	Beam Angle	CCT	Lumen (LM)
Normal	LX-DL-MT11SZ-32	Ø32*65mm	24-48VDC	0.092	4.0	4.4	>90	12°-45°	2700K	165lm
									3000K	170lm
									4000K	180lm

Note:

1. The output data is based on the testing result of Ra90,3000k luminaires;
2. The tolerance of output data can be vary up to 10%;
3. The output data is typical value.

Dimensions

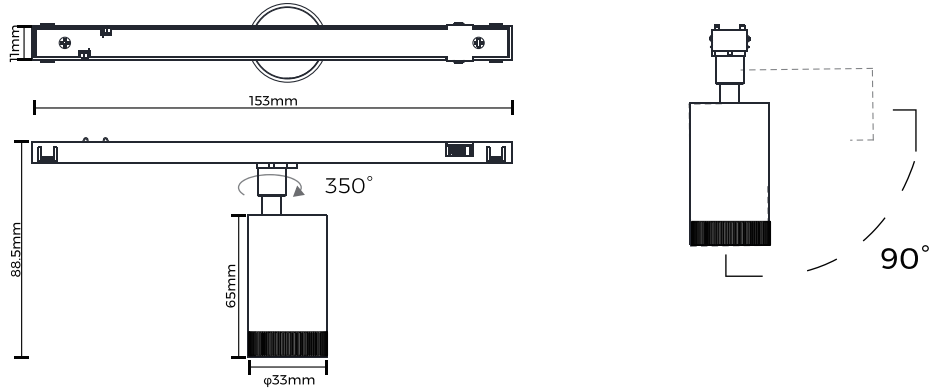

Optical Parameter

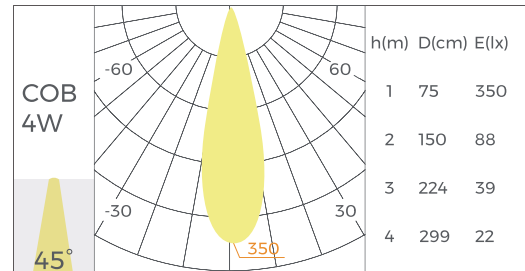
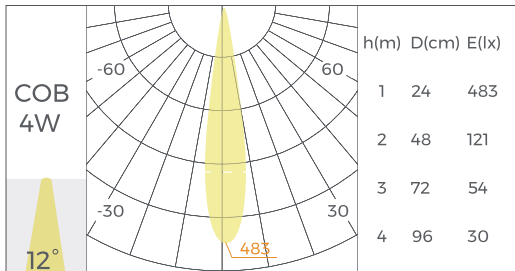

Points to note

48V Power Supply

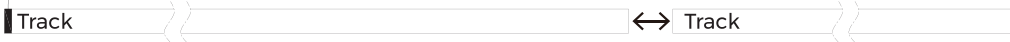

Total track Length ≤ 50M

48V Power Supply

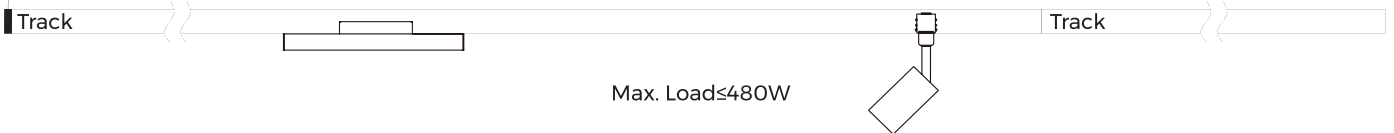

























Max. Load ≤ 480W

Supplementary power supplies are needed beside the Spotlights module / Decorative module / Linear modular under below one conditions:

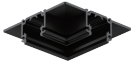
1. Load > 480W on the track
2. Total track length > 50M

Accessories Information

Picture	Name	Model
	Trimless recessed track (13mm gypsum board)	LX-MT11-RX0
	Ceiling track	LX-MT11-SX0
	Pendant track	LX-MT11-HX0
	Pendant track	LX-MT11-SRX0
	ø1000mm 90° Ceiling curve track	LX-MS111090
	Rail energization box	LX-MT1101
	Horizontal corner power-on connectors	LX-MT1102
	Flexible energized connectors	LX-MT1103
	Rail energized connectors	LX-MT1104
	Pendant accessory	LX-MT1105
	Rail connectors	LX-MT1106
	End caps	LX-MT11-R-EC
	End caps	LX-MT11-S-EC
	End caps	LX-MT11-H-EC

Picture	Name	Model
	End caps	LX-MT11-SR-EC
	L-shaped (Inward)	LX-L90N-MS11
	L-shaped (Downward)	LX-L90-MS11
	L-shaped (Inward)	LX-L90N-MR11
	L-shaped (Downward)	LX-L90-MR11
	L-shaped (Inward)	LX-L90N-MH11
	L-shaped (Downward)	LX-L90-MH11
	L-shaped (Downward)	LX-L90-MSR11
	48V Constant Voltage Power supply(external)	LX-V48-XXXP
	48V Constant Voltage Power supply(build-in)	LX-100W48CG MICRO

Note:

1,Please refer to the accessory list table for detailed parameters.

2,Different tracks need to be used with corresponding accessories